

## Airklima Inverter Wand Klimagerät AK8590vino

### Innengerät



Abmessungen (LxTxH)

805x194x285 mm

### Montage Innengerät

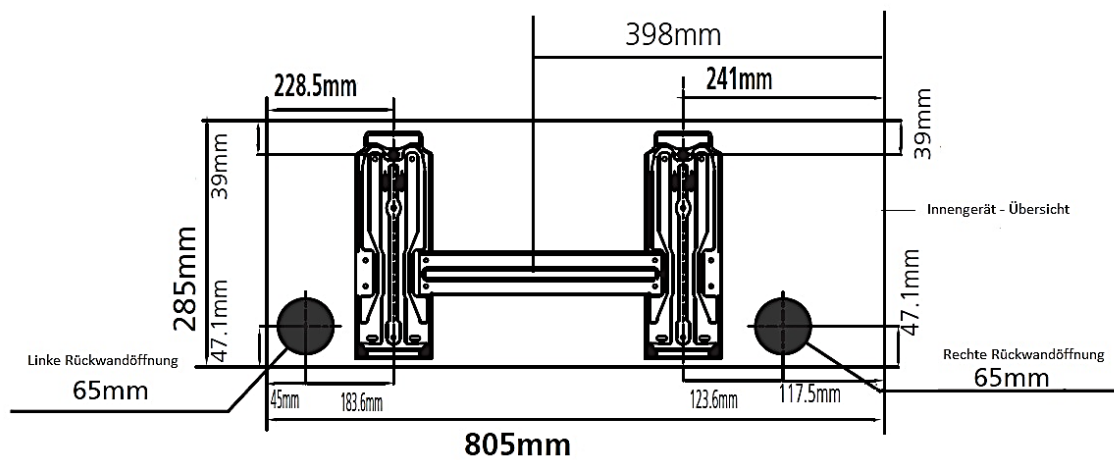

### Installation der Montageplatte

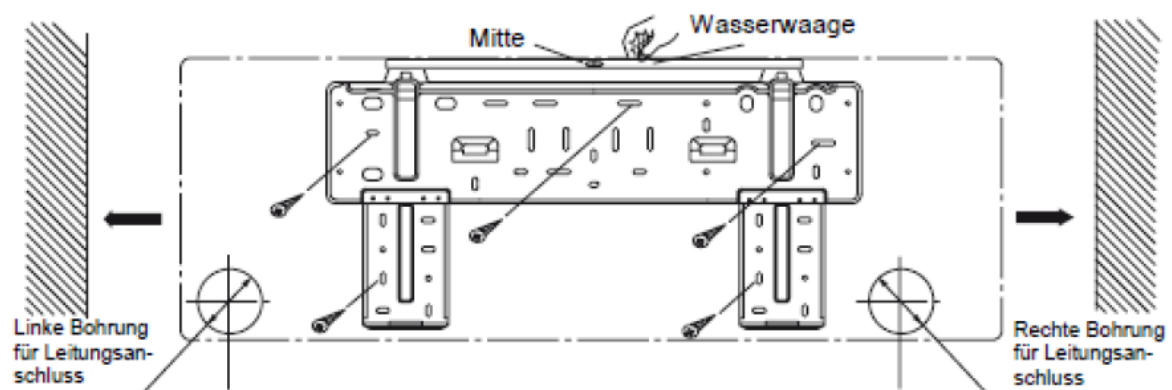

# Airklima - Klimaanlage

## Aussengerät

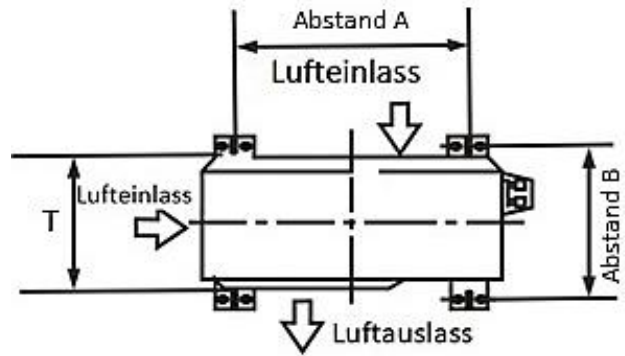
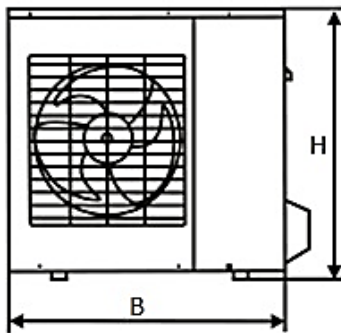

Abmessungen (LxTxH)

700x275x550 mm

Abstand A

450 mm

Abstand B

260 mm

B

700 mm

H

550 mm

T

275 mm