

Airklima Inverter Wand Klimagerät AK8590

Innengerät



Abmessungen (LxTxH)

805x194x285 mm

Montage Innengerät

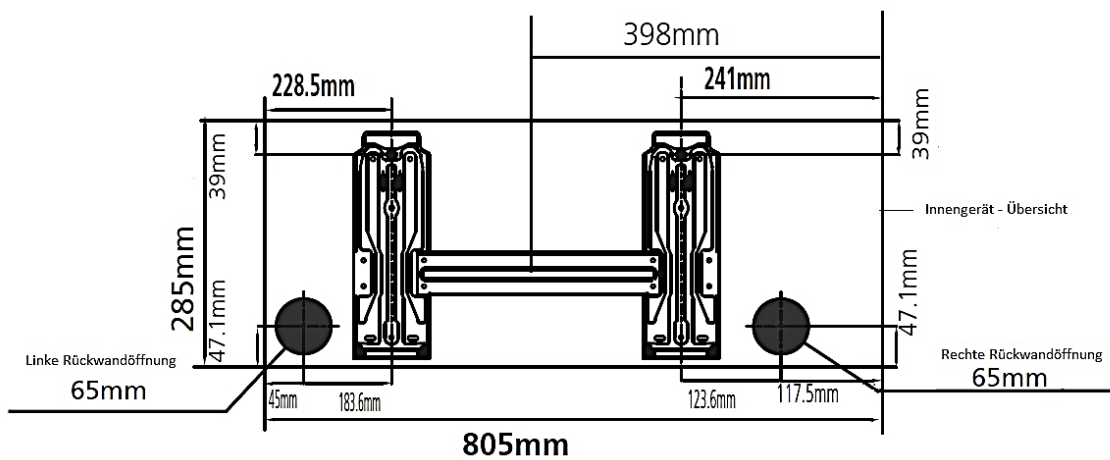

Installation der Montageplatte

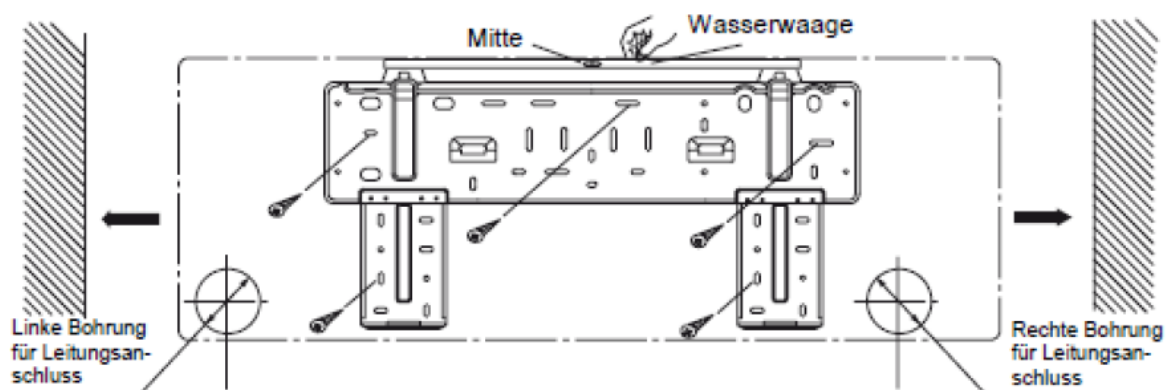

Airklima - Klimaanlage

Aussengerät

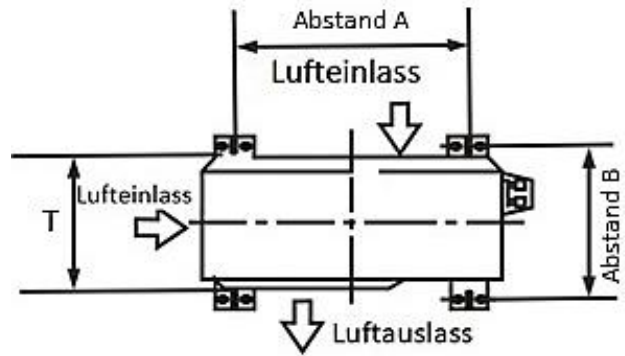
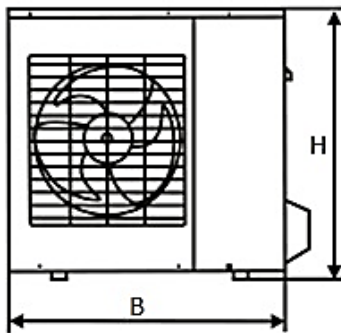

Abmessungen (LxTxH)

700x275x550 mm

Abstand A	450 mm
Abstand B	260 mm
B	700 mm
H	550 mm
T	275 mm